



800.606.11/900.606.11

Professional Finger Joint Bit







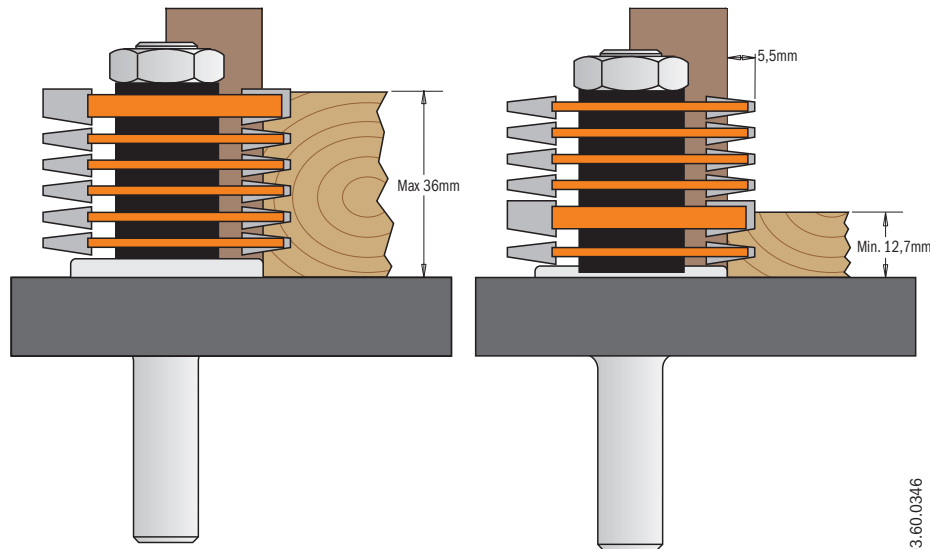

This versatile finger joint bit is the perfect tool for making incredibly strong side-to-side or end-to-end joints in wood and wood composites. The tightness and accuracy of the cut joint coupled with the maximum glue surface create a joint that is actually stronger than an unworked piece of wood. CMT's professional finger joint bit features two-flute design, carbide teeth and six removable cutters. This means you can make joints in a wide range of stock thicknesses - from 12,7mm (1/2") to 36mm (1-3/8"). Ideal for moulding manufacturers and furniture makers.

Drawings not to scale.

www.cmtorangetools.com

©: CMT, the CMT logo and the orange color applied to tool surfaces are trademarks of C.M.T. UTENSILI S.P.A. Any other brand names mentioned in CMT product catalogues and on the CMT website are the property of their respective owners.



ORDER NO. S=Ø12mm	ORDER NO. S=Ø12,7mm	Spare parts				
						
900.606.11		924.129.00	791.028.00	822.005.11	822.006.11	990.022.00
	800.606.11	824.129.00	791.028.00	822.005.11	822.006.11	990.022.00

Spare parts	541.511.00	3mm spacer	541.526.00	0,1mm spacer
	541.512.00	2mm spacer	990.458.00	Kit with spacer

ASSEMBLY SEQUENCE

ONE-FINGER

Minimum 11mm (7/16")
Maximum 16mm (5/8")



TWO-FINGER

Minimum 16mm (5/8")
Maximum 21mm (13/16")



THREE-FINGER

Minimum 21mm (13/16")
Maximum 26mm (1")

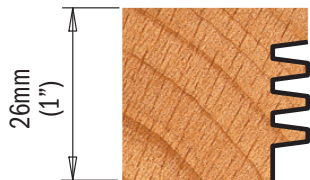

FOUR-FINGER

Minimum 26mm (1")
Maximum 31mm (1-13/16")

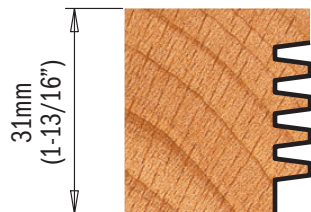

FIVE-FINGER

Minimum 31mm (1-7/32")
Maximum 36mm (1-3/8")

